

new

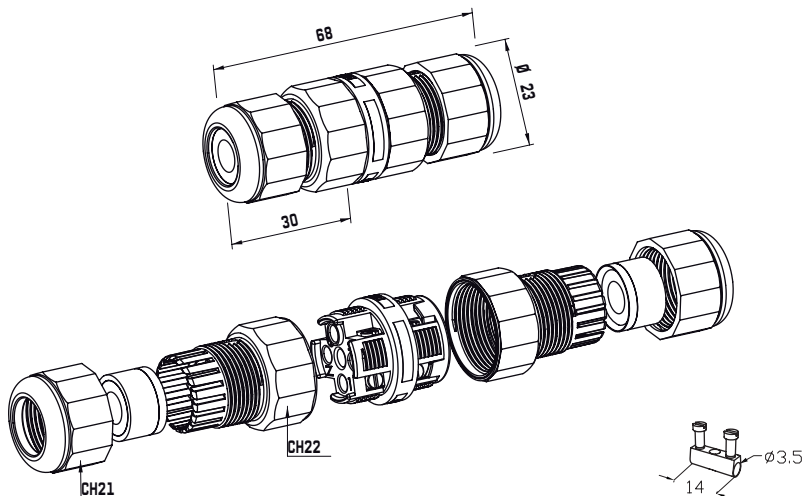

Dimensioni in millimetri. *Dimensions shown in millimetres.*

Dati generali *General data*

Dati tecnici *Technical data*

N. poli	2	3	4	N. poles
Terminali	vite/perforazione <i>screw/piercing</i>			Terminals
Sezione cavo	max 4.0 mm ² (bussola STD STD terminals) max 2.5 mm ² (bussola WP WP terminals) 0.5 mm ² - 1.5 mm ² (bussola a perforazione <i>piercing clip terminals</i>)			Cable section
Diametro cavi min-max ⁽¹⁾	7.0 mm - 12.0 mm			Cable diameter min-max ⁽¹⁾
Grado di protezione (IP)	IP68 3 bar (30 m - 2 h)			Degree of protection (IP)
Corrente e tensione nominale	17.5A 450V			Rated current and voltage
T marking	T85°C			T marking
Temperatura di funzionamento	-40°C to +125°C			Operating temperature
Indice di tracking	PTI 250			Tracking index
Materie prime <i>Raw materials</i>				
Corpo plastico morsetteria	PA66GF UL94 V0 GWT 960°C nero <i>black</i> - grigio <i>grey</i> RAL 7035			Terminal block housing
Pressacavi	PA66 UL94 V2			Cable glands
Guarnizioni co-stampate e gommini	TPE verde <i>green</i>			Co-moulded seals and grommets
Bussole	ottone nichelato <i>brass nickel plated</i>			Contact screw terminals
Viti standard	M3 acciaio zincato passivato <i>steel zinc plated</i>			Standard screws
Viti perforazione	M3 acciaio zincato ottonato <i>steel zinc brass plated</i>			Piercing screws



Norme *Standards*

EN60529:1991+A1:2000 EN60998-1:2004 EN60998-2-1:2004





Note: (1) Per cavi $\phi \leq 7.0$ mm si consiglia l'utilizzo dell'accessorio codice 6000347LA. *For cable $\phi \leq 7.0$ mm it is recommended to use the accessory code 6000347LA.*

Eventuali modifiche e migliorie sui dati tecnici o sul prodotto potranno essere effettuate senza preavviso.
All technical data or other eventual product modifications and improvements can be carried out without notice.

Codice Order number

versione version	n. poli n. poles	bussola contact terminal	pz/imb pcs/box	codice order number
  (1)	2		200	THB.391.A2A
			200	THB.391.A2C
	3		200	THB.391.A3A
			200	THB.391.A3C
	4		200	THB.391.A4A
			200	THB.391.A4C



Installazione a parete Panel-mounting installation

versione version	n. poli n. poles	bussola contact terminal	pz/imb pcs/box	codice order number
  (1)	2		200	THB.391.C2A
			200	THB.391.C2C
	3		200	THB.391.C3A
			200	THB.391.C3C
	4		200	THB.391.C4A
			200	THB.391.C4C
  (1)	2		200	THB.391.L2A
			200	THB.391.L2C
	3		200	THB.391.L3A
			200	THB.391.L3C
	4		200	THB.391.L4A
			200	THB.391.L4C
Le versioni sopra indicate sono disponibili con terminali a perforazione di isolante The above versions are available with piercing clip terminal blocks			200	THP.391.xxA



Note: Bussola cieca End barrier contact Bussola WP per sezione cavo WP contact for cable section < 1.0 mm²
 Bussola a perforazione max 1.5 mm² Piercing clip terminals max 1.5 mm²
 (1) Simbologia differente su richiesta. Different markings on request.

VERSIONI ANTI-CONDENSA ANTI-CONDENSATION VERSIONS



Codice Order number

versione version	n. poli n. poles	bussola contact terminal	pz/imb pcs/box	codice order number
   (1)	4		200	THB.391. R4A

Installazione a parete Panel-mounting installation



versione version	n. poli n. poles	bussola contact terminal	pz/imb pcs/box	codice order number
  (1)	4		200	THB.391. S4A

Viti e dado di fissaggio da ordinare a parte
Fixing screws or nut to be ordered separately

  (1)	4		200	THB.391. T4A
--	---	---	-----	---------------------

Dado di fissaggio incluso
Fixing nut included

Le versioni sopra indicate sono disponibili con terminali a perforazione di isolante
The above versions are available with piercing clip terminal blocks

Note:  Bussola cieca End barrier contact  Bussola WP per sezione cavo WP contact for cable section < 1.0 mm²
 Bussola a perforazione max 1.5 mm² Piercing clip terminals max 1.5 mm²
 (1) Simbologia differente su richiesta. Different markings on request.

**COME FUNZIONA LA PROTEZIONE ANTI-CONDENSA
HOW THE ANTI-CONDENSATION CONNECTOR WORKS**

La speciale barriera anti-condensa protegge il sistema in condizioni critiche di utilizzo. Il prodotto impedisce all'umidità, che attraverso il cavo raggiunge la connessione, di entrare all'interno dell'apparecchio.

The special barrier prevents moisture condensation, which runs through the cable, from entering the system in critical conditions of use.





BARRIERA ANTI-CONDENSA
ANTI-CONDENSATION BARRIER

CONDENSA ALL'INTERNO DEL CAVO
CONDENSATION INSIDE THE CABLE

Eventuali modifiche e migliorie sui dati tecnici o sul prodotto potranno essere effettuate senza preavviso.
All technical data or other eventual product modifications and improvements can be carried out without notice.

Accessori da ordinare separatamente *Accessories must be ordered separately*

Altri accessori *Other accessories (only for THB.391.Cxx / THB.391.Sxx)*

versione <i>version</i>	codice <i>order number</i>	descrizione <i>description</i>
	6000212CC	dado nero per fissaggio a parete (figura 1) <i>black nut for panel-mounting installation (figure 1)</i>
	601000600	vite per fissaggio a parete (figura 2) <i>screws for panel-mounting installation (figure 2)</i>

Note: Quantità minima ordinabile 200 pezzi. *Minimum order quantity 200 pieces.*

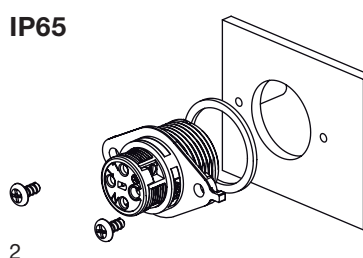
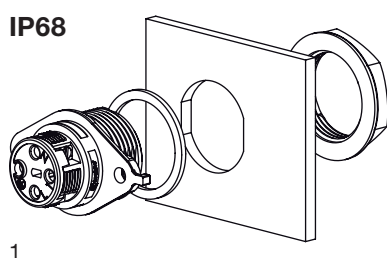

Varianti *Options*

Colore *Colour*

versione <i>version</i>	codice <i>order number</i>
<input checked="" type="checkbox"/> grigio <i>grey</i> RAL 7035	THx.391.xxx.CG
<input type="checkbox"/> altri colori <i>other colours</i> Contatta il Servizio Clienti per maggiori informazioni. <i>Contact our Customer Service for availability.</i>	THx.391.xxx.CX



Kit di fornitura *Purchasing kit*

versione <i>version</i>	misure imballaggio <i>box measures</i>	contenuto <i>contents</i>	pz/imb <i>pcs/box</i>	codice <i>order number</i>
kit non assemblato <i>unassembled kit</i>	C02 (400x160x205 mm)		200	THx.391.xxx
kit assemblato <i>assembled kit</i>	C02 (400x160x205 mm)		200	THx.391.xxx.Z
kit imbustato <i>retail pack kit</i> Consulta il catalogo Rivenditori. <i>See the Retailers catalogue.</i>	--		--	THx.391.xxx.R
versione speciale <i>custom version</i>	*	*	*	THx.391.xxx.K

Note: Per maggiori informazioni sulle istruzioni di assemblaggio consulta pagina www.techno.it.
For more information about assembling instructions see www.techno.it.

Accessori Accessories

Dadi Lock nuts

versione version	codice order number	colore colour	descrizione description	
	6DB025200	nero black	tappo di chiusura per THx.391.Lxx / THx.391.Txx closure cap for THx.391.Lxx / THx.391.Txx	200
	6DB02210C	nero black	tappo di chiusura per THx.391.Cxx / THx.391.Sxx closure cap for THx.391.Cxx / THx.391.Sxx	200
	6DB02210E	grigio RAL7035 grey RAL7035		

Altri accessori Other accessories

versione version	codice order number	colore colour	descrizione description	
	6000302CC	nero black	supporto per connettori panel mounting clip	200
	6000302CE	grigio RAL7035 grey RAL7035	supporto per connettori panel mounting clip	200
	6000337BC	nero black	chiave calibrata per il fissaggio del cavo special tool to fix the cable	100

Note: (1) Utilizzabile con doppio gommino fornito nel prodotto standard. *To be used with the double-grommet supplied with the standard product version.*



Cavo co-stampato disponibile su richiesta.
Over-moulded cable available upon customer request.

Caratteristiche e vantaggi Features and benefits



Design compatto. Connettore di piccole dimensioni per applicazioni in spazi ridotti.
Compact design. Mini-connector for use in tight spaces.

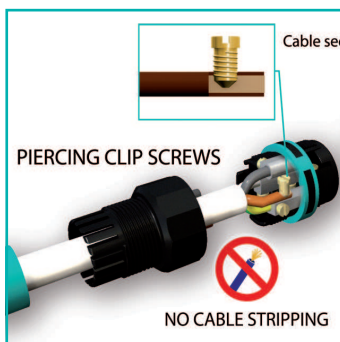

Installazioni rapide. Il cablaggio a perforazione di isolante consente una sicura e veloce installazione.
Cost effective. Quick installation.
The piercing clip wiring system ensures safe and fast installations.



Sicurezza. Con l'accessorio di chiusura si assicura la corretta installazione del prodotto per una protezione totale IP68.
Safety. The special tool ensures the correct installation of the product for a maxim protection IP68.



Alta protezione. Connessioni possibili con massimo grado di protezione IP68, resistenti ad acqua e polveri.
High protection. Possible connections with the highest degree of protection IP68, resistant to water and dust.

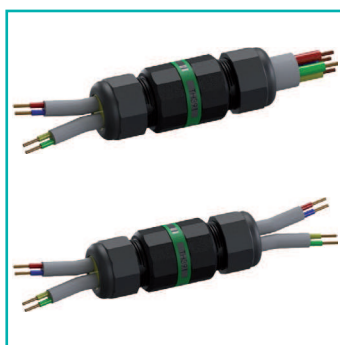

Massima versatilità. Molteplici utilizzi e versioni del connettore TH391.
Maximum versatility. Many versions and applications for the TH391 connector.



Massima versatilità. Molteplici utilizzi e versioni del connettore TH391.
Maximum versatility. Many versions and applications for the TH391 connector.



Massima versatilità. Molteplici utilizzi e versioni del connettore TH391.
Maximum versatility. Many versions and applications for the TH391 connector.



Massima versatilità. Molteplici utilizzi e versioni del connettore TH391.
Maximum versatility. Many versions and applications for the TH391 connector.



Massima versatilità. Molteplici utilizzi e versioni del connettore TH391.
Maximum versatility. Many versions and applications for the TH391 connector.

Dimensioni *Dimensions*



THx.391.Axx



Ø 23

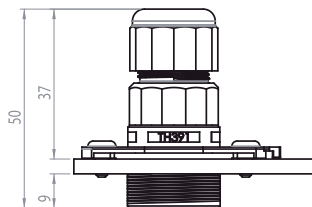

THx.391.Cxx

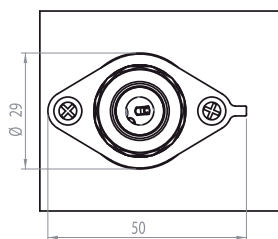

Ø 29

50

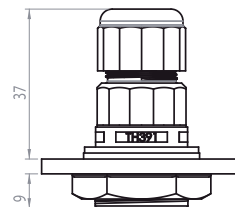

THx.391.Lxx

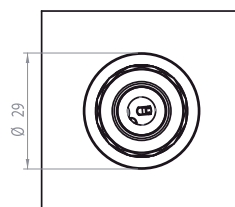

Ø 29



THx.391.Rxx



Ø 23

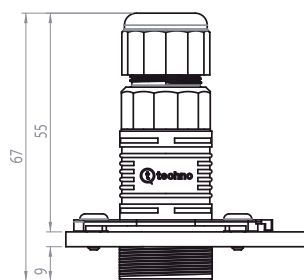

THx.391.Sxx

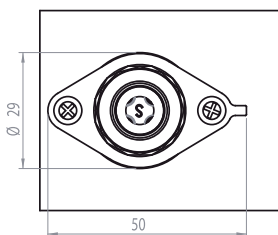

Ø 29

50



THx.391.Txx

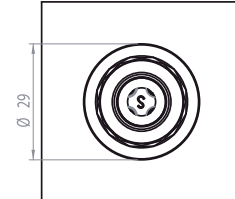

Ø 29