

Mischpol D-Sub

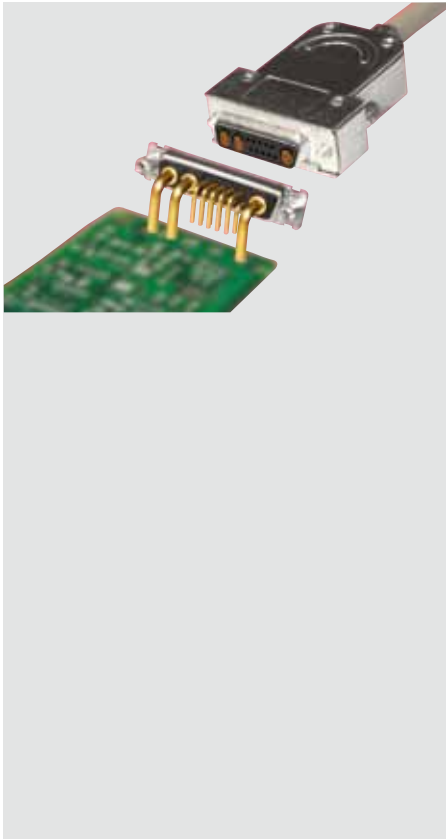

Unser Mischpol D-Sub Steckverbinder-Programm umfasst ein komplettes Produkt-Portfolio für den Leiterplatten- oder Kabelanschluss mit verschiedenen Kontaktkonfigurationen für reine Sonderkontakt-Bestückung oder in Mischbestückung mit Signal- und Sonderkontakten. Gedrehte Kontakte und massives Befestigungszubehör ermöglichen hochwertige anwendungsgerechte Lösungen und kundenspezifische Applikationen. Die passenden D-Sub Hauben finden Sie in dem Bereich Hauben.

Für den Leiterplattenanschluss

- Steckverbinder mit 180° und mit 90°-Einlötlanschluss
- Gerade Steckverbinder mit Boardlock- oder CombiLock- (Boardlock mit integriertem Gewindeniet)-Befestigungsbolzen für die sichere Masseverbindung und Verrastung auf der Leiterplatte
- Abgewinkelte Steckverbinder mit massivem Metallwinkel mit Rastclip für die sichere Masseverbindung

Für den Kabelschluss

- Crimpsteckverbinder mit Signal-Crimpkontakten in gedrehter oder gestanzter Ausführung
- Crimp-Sonderkontakt-Versionen:
Hochstrom-Crimpkontakte von 10 A bis 40 A;
Koax-Crimpkontakte: 50 Ohm
- Handlöt-Sonderkontakt-Versionen:
Hochstrom-Handlötkontakte von 10 A bis 40 A
- D-Sub Hauben in Kunststoff, metallisiert und Zinkdruckguss-Vollmetall

Mixed Layout D-Sub

Our Mixed Layout D-Sub connector range includes a complete product portfolio for the circuit board application and cable assemblies with different contact configurations for connectors with only special contacts or combined connectors with signal and special contacts. Turned contacts and solid mounting accessories allow secure high-quality solutions and customer-specific applications. You can find the suitable D-Sub hoods in the hoods range.

For circuit board applications

- Connectors with 180° and with 90°-solder pin
- Straight PCB connectors with solid boardlock and combilock (boardlock with integral riveted thread) mounting bolts for secure grounding and snap-in locking on the pcb.
- Right angle PCB connectors with solid metal bracket with snap-in clip for secure grounding

For cable assemblies

- Crimp connectors with signal crimp contacts in turned or stamped version
- Special crimp contact versions:
high power crimp contacts from 10 A to 40 A;
coax crimp contacts: 50 Ohm
- Special solder cup contact version: high power solder cup contacts from 10 A to 40 A
- D-Sub hoods in plastics, metallized, and zinc die cast version available

Technische Informationen / Technical Information			
Technische Daten / Technical Data	Signalkontakte / Signal Contacts	Hochstromkontakte / High Power Contacts	Koax-Kontakte / Coax Contacts
Strombelastbarkeit in A (DC) bei 20° C / Current rating in A (DC)	5	10-40	2
Prüfspannung U _{eff} in V / Test voltage U _{eff} in V	Kontakt - Kontakt: 1000 Contact - Contact: 1000 Kontakt - Masse: 1200 Contact - Ground: 1200	1000	1000
Luft- und Kriechstrecken in mm / Air and creepage distance in mm	Kontakt - Kontakt: min. 1 Kontakt - Masse: min. 1,2	≥ 1	≥ 1
Durchgangswiderstand in mW / Resistance in mW	≤ 10	≤ 1	Innenleiter / inner conductor ≤ 10 Aussenleiter / outer conductor ≤ 3
Isolationswiderstand in GW / Insulation resistance in GW	≥ 10	≥ 10	≥ 10
Temperaturbereich in °C / Temperature range in °C	-55 ... +125	-55 ... +125	-55 ... +125
Gesamt-Steck-/Ziehkraft in N / Mating/unmating force fully loaded connector in N			
Gehäuse Größe / Shell size	≤ 30	≤ 10 (per Kontakt) ≤ 10 (per Contact)	≤ 10 (per Kontakt) ≤ 10 (per ContaCt)
Gehäuse Größe / Shell size	≤ 50		
Gehäuse Größe / Shell size	≤ 83		
Gehäuse Größe / Shell size	≤ 123		
Gehäuse Größe / Shell size	≤ 167		
Materialien / Materials			
Isolierkörper / Insulators	PBT GF UL 94-V0		
Kontakte / Contacts			
Werkstoff / Materials	Cu-Legierung / Cu alloy	Cu-Legierung / Cu alloy	Cu-Legierung / Cu alloy
Oberfläche / Plating	Steckbereich / Mating area: Au über Ni / Au over Ni Anschlussbereich / Termination area: Sn über Ni / Sn over Ni	Au über Ni / Au over Ni	Au über Ni / Au over Ni
Gehäuse / Housing	Stahl, verzinkt / St. tinned		
Halteclip / Retaining clip		CuBe	CuBe

Mischpolleisten Einlöt 90°

Mixed Layout Dip solder 90°

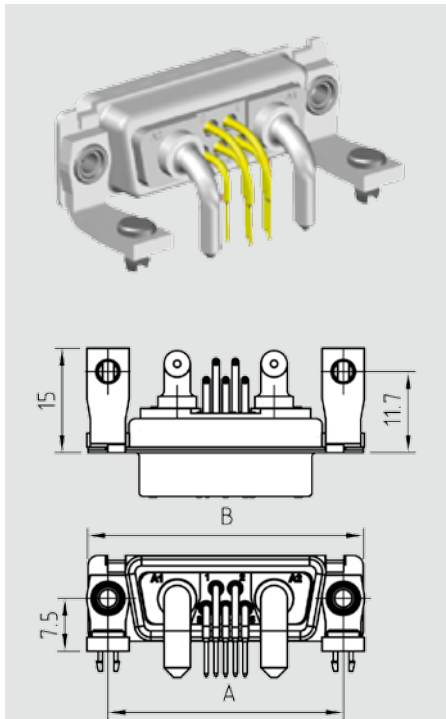

Polanordnung
Arrangement

3W3

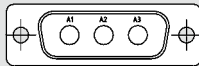

3W3C

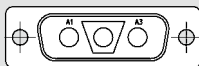

7W2

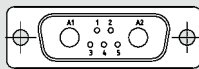

5W5

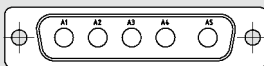

13W3

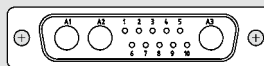

17W2

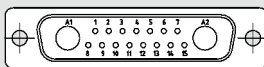

8W8

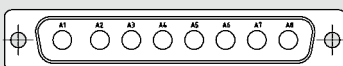

21W4

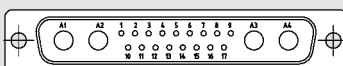

	Kontaktanordnung/ Contact arrangement	Stift Male	Buchse Female	Abmessungen in mm Dimensions in mm	
				A	B
Einlöt 90° Metallwinkel mit Gewindeniet Dip solder 90° with metal bracket and thread	3W3	PDT3W3P6xG248	PT3W3S6xG248	33,3	39,0
	3W3C	PDT3W3CP6xG248	PT3W3CS6xG248	33,3	39,0
	7W2	PDT7W2P6xG248	PT7W2S6xG248	33,3	39,0
	5W5	PDT5W5P6xG248	PT5W5S6xG248	33,3	39,0
	13W3	PDT13W3P6xG248	PT13W3S6xG248	33,3	39,0
	17W2	PDT17W2P6xG248	PT17W2S6xG248	33,3	39,0
	8W8	PDT8W8P6xG248	PT8W8S6xG248	47,0	52,8
Einlöt 90° Metallwinkel mit Gewindeniet und Rastclip Dip solder 90° with metal bracket, locking clip and thread	3W3	PDT3W3P6xG2R48	PT3W3S6xG2R48	47,0	52,8
	3W3C	PDT3W3CP6xG2R48	PT3W3CS6xG2R48	47,0	52,8
	7W2	PDT7W2P6xG2R48	PT7W2S6xG2R48	47,0	52,8
	5W5	PDT5W5P6xG2R48	PT5W5S6xG2R48	47,0	52,8
	13W3	PDT13W3P6xG2R48	PT13W3S6xG2R48	63,5	69,2
	17W2	PDT17W2P6xG2R48	PT17W2S6xG2R48	63,5	69,2
	8W8	PDT8W8P6xG2R48	PT8W8S6xG2R48	63,5	69,2
21W4	PDT21W4P6xG2R48	PT21W4S6xG2R48	63,5	69,2	

Sonderkontakttyp Special contact version		Oberfläche Plating		Gewindetyp Thread type	
Px/ Sx	0 ohne Sonderkontakte 0 no special contacts	Gütestufe Class	Steckzyklen Mating cycles	4	UNC 4-40
	1 Hochstrom 10A 1 High Power 10A	G1	500	3	M3
	2 Hochstrom 20A 2 High Power 20A	G2	200		
	3 Hochstrom 30A 3 High Power 30A	G3	50		
	4 Hochstrom 40A 4 High Power 40A				

! Bitte anstelle des x in der Artikelnummer die gewünschte Sonderkontaktversion einfügen.

For the requested special contact please replace the x with the desired special contact version.

**Leiterplattenlochbild
Einlöt 90° /
Dip solder 90°**

**PCB Hole Pattern
Einlöt 180°
Dip solder 180°**

Allgemeine Maße – nach Ausführung 7W2 (in rot)

General Dimensions – acc. to version 7W2 (in red)

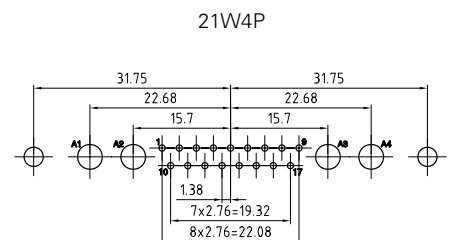
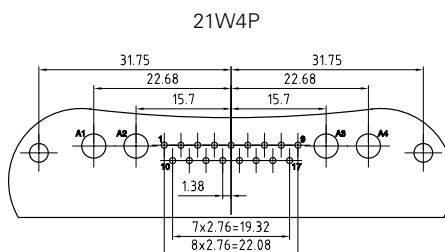
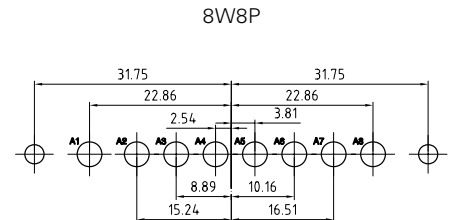
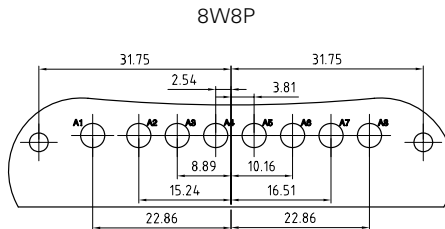
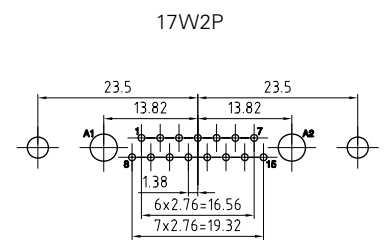
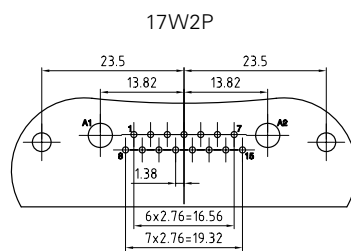
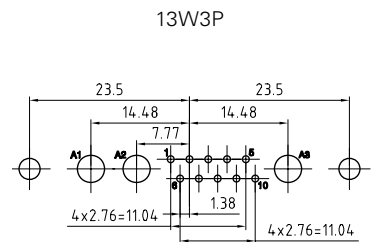
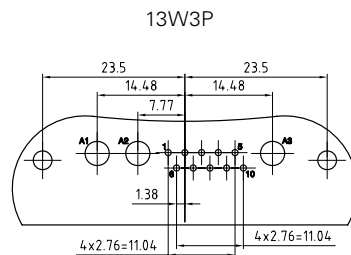
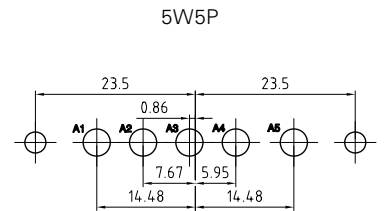
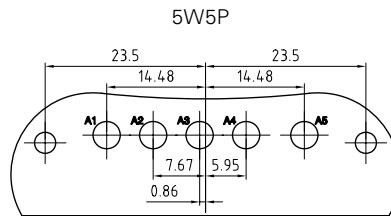
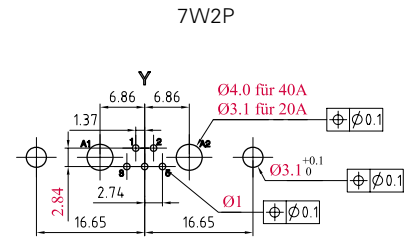
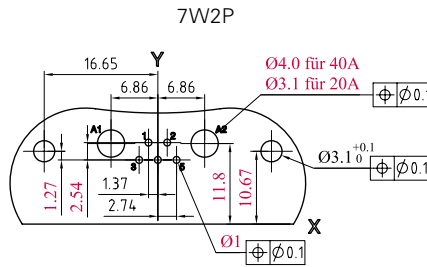
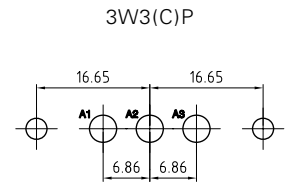
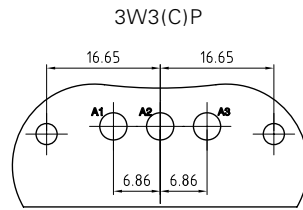

Lochbilder sind für Stift angegeben; bei Buchse müssen die Bilder an der Y-Achse gespiegelt werden.

PCB Hole Pattern shown for male version; for female version the PCB Hole Pattern has to be mirrored on the Y-axis.