

**CE** **Nemko** **RoHS**  
**IP54** **IP66** **IP68**

Dimensioni in millimetri. *Dimensions shown in millimetres.*  
Dimensioni interne utili 43 x 53.5 x 24 mm. *Inner dimensions 43 x 53.5 x 24 mm.*

## Dati generali *General data*

### Dati tecnici *Technical data*

Diametro cavo min-max	7.0 mm - 14.0 mm	<i>Cable diameter min-max</i>
Grado di protezione (IP)	IP54 - IP66 - IP68 0.5 bar (5 m / 3 h)	<i>Degree of protection (IP)</i>
Prova di riscaldamento	T85°C 16A	<i>Rated current and voltage</i>
Temperatura di funzionamento	-40°C to +125°C	<i>Heating resistance test report</i>

### Materie prime *Raw materials*

Corpo plastico	PA66 UL94 V2 GWT 850°C nero <i>black</i> - grigio <i>grey</i> RAL 7035	<i>Body</i>
Dadi	PA66 FV UL94 V0 GWT 960°C nero <i>black</i> - grigio <i>grey</i> RAL 7035	<i>Lock nuts</i>
Guarnizione co-stampata coperchio	SEBS	<i>Co-moulded seal of lid</i>
Gommini di tenuta cavo	TPE	<i>Grommets</i>
Viti di fissaggio coperchio	M3 x 12.0 mm inox <i>stainless steel</i>	<i>Fixing screws of lid</i>

### Norme *Standards*



TEST REPORT  
EN60529:1991+A1:2000  
IP54: 2.6 l/min 10 min  
IP68: 5 MT-PROOF 3 h  
IP66: 100 l/min 3 min  
EN60998-1:2004  
heating resistance

# TH209 PATENTED

SCATOLA DI DERIVAZIONE AD ALTA PROTEZIONE. 3-4 USCITE.  
HIGH PROTECTION WATERPROOF JUNCTION BOX. 3-4 WAYS.

TH209

## Codice Order number

versione version	Ø min-max cavo Ø cable min-max	IP IP	pz/imb pcs/box	codice order number	
	<b>A</b> 7.0 - 14.0 mm <b>B</b> 7.0 - 14.0 mm	IP68	100	THA.209. <b>A1A</b>	
		IP54	100	THA.209. <b>A1B</b>	
	<b>A</b> 7.0 - 9.5 mm <b>B</b> 7.0 - 14.0 mm	IP68	100	THA.209. <b>B1A</b>	
		IP54	100	THA.209. <b>B1B</b>	
	<b>A</b> 7.0 - 9.5 mm <b>B</b> 7.0 - 9.5 mm	IP68	100	THA.209. <b>C1A</b>	
		IP54	100	THA.209. <b>C1B</b>	
		<b>A</b> 7.0 - 14.0 mm <b>B</b> 7.0 - 14.0 mm	IP68	100	THA.209. <b>D1A</b> <span style="background-color: #00a651; color: white; border-radius: 50%; padding: 2px;">new</span>
			IP54	100	THA.209. <b>D1B</b> <span style="background-color: #00a651; color: white; border-radius: 50%; padding: 2px;">new</span>
<b>A</b> 7.0 - 9.5 mm <b>B</b> 7.0 - 14.0 mm		IP68	100	THA.209. <b>E1A</b> <span style="background-color: #00a651; color: white; border-radius: 50%; padding: 2px;">new</span>	
		IP54	100	THA.209. <b>E1B</b> <span style="background-color: #00a651; color: white; border-radius: 50%; padding: 2px;">new</span>	

**Note:** Ø cable min-max 7.0 - 9.5 mm CH Ø 19.0 mm (for Ø cable ≤ 7.0 mm it is recommended to use the accessory code 6000041LF)  
Ø cable min-max 7.0 - 14.0 mm CH Ø 24.0 mm (for Ø cable ≤ 7.0 mm it is recommended to use the accessory code 6000087LF)

## Varianti Options

**Colore Colour** Contatta il Servizio Clienti per maggiori informazioni. *Contact our Customer Service for availability.*

versione version	codice order number
<input checked="" type="checkbox"/> grigio grey RAL 7035	THA.209.XXX.CG
<input type="checkbox"/> altri colori other colours	THA.209.XXX.CX

## Kit di fornitura Purchasing kit

versione version	misure imballaggio box dimensions	contenuto contents	pz/imb pcs/box	codice order number
kit non assemblato unassembled kit	C07 (590x390x240 mm)		100	THA.209.XXX
kit assemblato assembled kit	C05 (395x395x185 mm)		100	THX.209.XXX.Z
kit imbustato retail pack kit Consulta il catalogo Rivenditori. See the Retailers catalogue.	--		--	THX.209.XXX.R
versione speciale custom version	*	*	*	THX.209.XXX.K

**Note:** Per maggiori informazioni sugli accessori consulta pagina 168. Per maggiori informazioni sulle istruzioni di assemblaggio consulta pagina www.techno.it.  
*For more information about accessories see page 168. For more information about assembling instructions see page www.techno.it.*

**\* Sono possibili personalizzazioni di prodotto e progetti su richieste specifiche. Contatta il Servizio Clienti.**  
*Personalization and new custom products are possible. Please contact our Customer Service.*

Eventuali modifiche e migliorie sui dati tecnici o sul prodotto potranno essere effettuate senza preavviso.  
*All technical data or other eventual product modifications and improvements can be carried out without notice.*

## Come scegliere la morsettieria *How to choose the terminal block*

versione version	morsettieria terminal block	n. poli n. poles	serie series	codice order number	accessori accessories
		2 - 3	TH026 <sup>(1)</sup>	Vai a pagina 316 See page 316	 codice / order number <b>6000175CC<sup>(1)</sup></b>
		5			
		3 - 3	TH026 <sup>(1)</sup>	Vai a pagina 316 See page 316	 codice / order number <b>6000176CC<sup>(1)</sup></b>
			2 + 2 3 + 3	TH029 <sup>(1)</sup>	Vai a pagina 320 See page 320
		4 + 4	TH032 <sup>(1)</sup>	Vai a pagina 322 See page 322	
		2 - 3	TH027 <sup>(1)</sup>	Vai a pagina 318 See page 318	 codice / order number <b>6000175CC<sup>(1)</sup></b>

**Note:** (1) Le morsettiere e gli accessori devono essere ordinati separatamente.  
*Terminal blocks and accessories must be ordered separately.*

## Esempi *Examples*

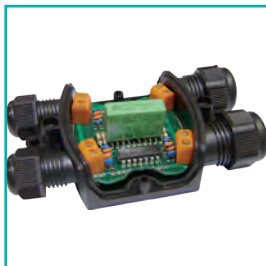

Scheda elettronica  
*Electronic circuit boards*

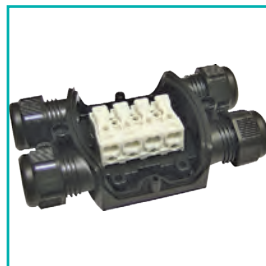

Morsettieria a molla  
*Terminal block with spring*

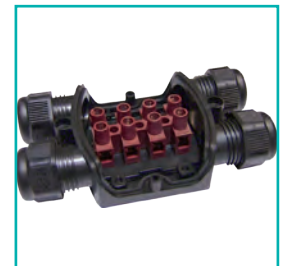

Morsettieria STD passo 12  
*Standard terminal block 12*

Eventuali modifiche e migliorie sui dati tecnici o sul prodotto potranno essere effettuate senza preavviso.  
*All technical data or other eventual product modifications and improvements can be carried out without notice.*

## Caratteristiche e vantaggi *Features and benefits*



**Connessioni protette all'acqua affidabili** e ispezionabili, non necessitano l'utilizzo di gel/resina.  
**High protection waterproof reliable connectors.** Avoid the use of gel/resin. Inspection of inner connector possible.



**Evita errori di installazione.** Co-stampaggio di plastica e gomma. Guarnizione non rimovibile garantisce una corretta installazione.  
**Avoid installation errors.** Gasket co-moulded with lid prevents accidental removal of the seal for a reliable connection.

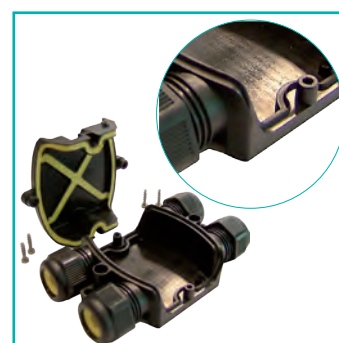

**Elevata qualità e cura dei dettagli.** Speciale profilo migliora l'adesione del coperchio. Perfetta tenuta anche in condizioni verticali.  
**High quality and care of details.** Special profile makes sure the lid is perfectly installed. High reliability also in vertical installation.



**Inserti disponibili in versione:**  
A) passante, B) lamella premi cavo, C) perforazione.  
**Metal inserts available:**  
A) pass-through, B) wire-protection, C) piercing.

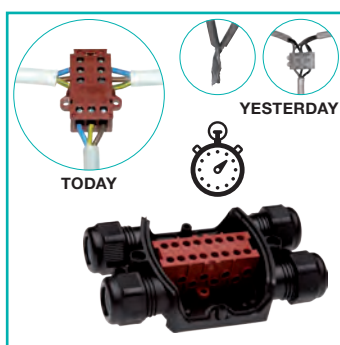

**Innovazione di prodotto.** Cablaggio rapido di derivazioni. Si evita di attorcigliare il trefolo.  
**Product innovation.** Fast wiring of electrical derivations. Avoid twisting the top of the wire.

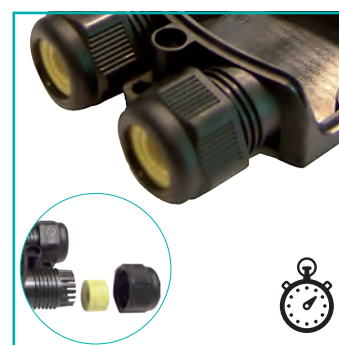

**Installazione veloce e sicura.** Pressacavi incorporati nella base con griffe evitano rimozione accidentale del gommino.  
**Quick and secure installation.** Built-in cable glands with knurled clips improve safety locking on the cable and avoid accidental seal removal.



**Personalizzabili.** Versioni trasparenti e colorate su richiesta del cliente.  
**Custom products.** Transparent and colour versions on customer request.



**Compatibilità** con guaine corrugate, guida cavi e calze espandibili.  
**Fitting** with braided hose, spiral top and cable protection systems.

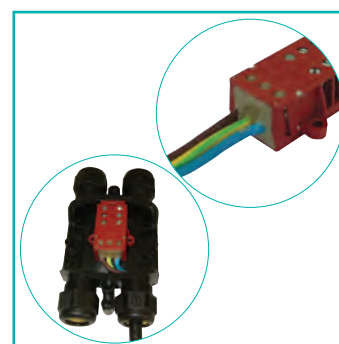

**Protezione dalla condensa** con resina ad alto potere isolante, garantisce l'integrità degli apparecchi nel tempo.  
**Protection from moisture condensation** with a special resin with excellent insulation capacity, ensures integrity of equipments over time.