

JDV CONNECTOR

1.5mm pitch/Hinge type Board-to-board Connectors

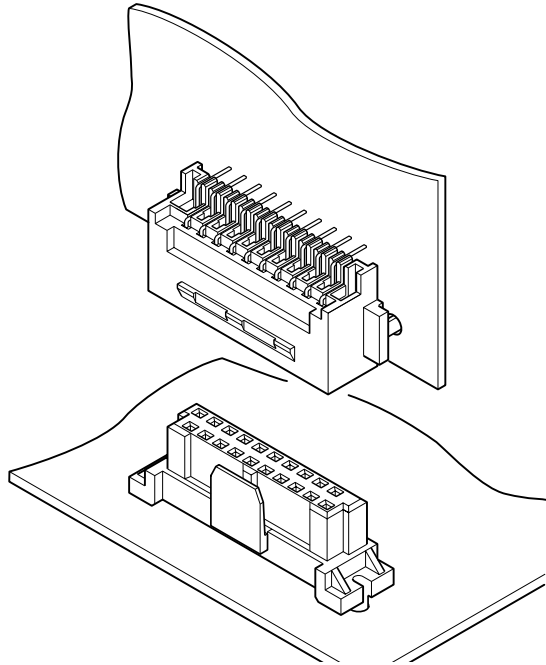

The JDV connector is designed for board-to-board connection with locking device, and highly resistant to equipment vibration and shock.

- Two type Locking device
- Staggered Solder Tails
- Positioning boss (projection)

Specifications

- Current rating: 1.0A AC, DC
- Voltage rating: 50V AC, DC
- Temperature range: -25°C to +85°C
(including temperature rise in applying electrical current)
- Contact resistance: Initial value/30m Ω max.
After environmental testing/50m Ω max.
- Insulation resistance: 800M Ω min.
- Withstanding voltage: 300V AC/minute
- Applicable PC board thickness: 1.6mm
- * Compliant with RoHS.
- * Refer to "General Instruction and Notice when using Terminals and Connectors" at the end of this catalog.
- * Contact JST for details.

Standards

Recognized E60389

Certified LR20812

PC board layout (viewed from component side) and Assembly layout

Plug

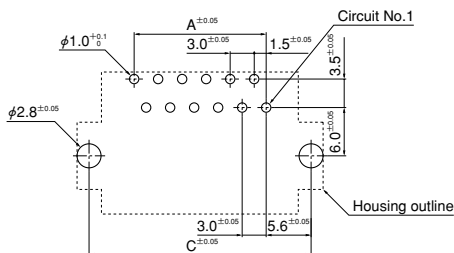

Receptacle

Resin hook type

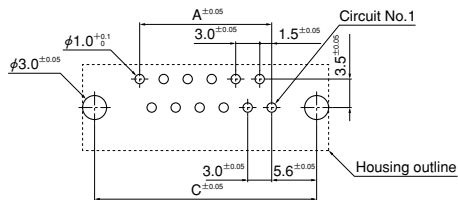

Metal hook type

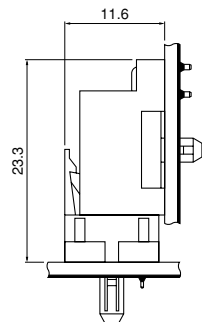
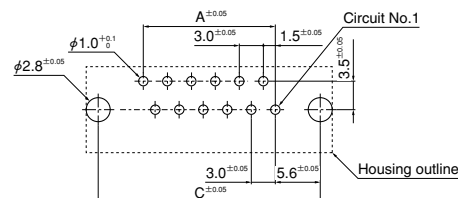

Note: 1. Tolerances are non-cumulative: $\pm 0.05\text{mm}$ for all centers.

2. Hole dimensions differ according to the kind of PC board and piercing method. The dimensions above should serve as a guideline. Contact JST for details.

JDV CONNECTOR

Plug

Retention lock type Resin hook type

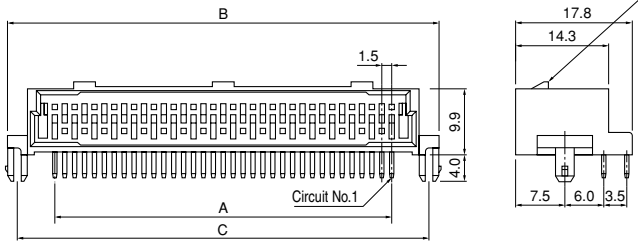

Enlarged views of lock shape are as follows.

Metal hook type

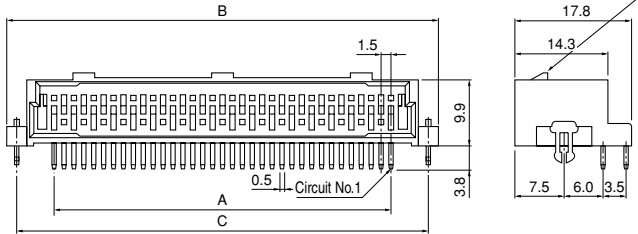

Enlarged views of lock shape are as follows.

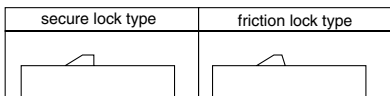

Resin hook type

Circuits	Model No.		Dimensions (mm)			Qty / box
	secure lock type	friction lock type	A	B	C	
15	JDV-PS15LB-10-1	—	21.0	35.5	32.2	400
20	JDV-PS20LB-10-1	JDV-PS20FLB-10-1	28.5	43.0	39.7	320
25	JDV-PS25LB-10-1	JDV-PS25FLB-10-1	36.0	50.5	47.2	280
30	JDV-PS30LB-10-1	JDV-PS30FLB-10-1	43.5	58.0	54.7	240
35	JDV-PS35LB-10-1	JDV-PS35FLB-10-1	51.0	65.5	62.2	200
40	JDV-PS40LB-10-1	JDV-PS40FLB-10-1	58.5	73.0	69.7	160
50	JDV-PS50LB-10-1	JDV-PS50FLB-10-1	73.5	88.0	84.7	160

Material and Finish

Contact: Brass, nickel-undercoated, Mating part; gold-plated
Solder tail; tin-plated (reflow treatment)
Housing: Glass-filled PBT, UL94V-0

RoHS compliance This product displays (LF)(SN) on a label.

Metal hook type

Circuits	Model No.		Dimensions (mm)			Qty / box
	secure lock type	friction lock type	A	B	C	
20	JDV-PS20LB-10A	—	28.5	43.0	39.7	320
25	JDV-PS25LB-10A	—	36.0	50.5	47.2	280
30	JDV-PS30LB-10A	JDV-PS30FLB-10A	43.5	58.0	54.7	240
35	JDV-PS35LB-10A	JDV-PS35FLB-10A	51.0	65.5	62.2	200
40	JDV-PS40LB-10A	—	58.5	73.0	69.7	160
50	JDV-PS50LB-10A	JDV-PS50FLB-10A	73.5	88.0	84.7	160
65	—	JDV-PS65FLB-10A	96.0	110.5	107.2	120

Material and Finish

Contact: Brass, nickel-undercoated, Mating part; gold-plated
Solder tail; tin-plated (reflow treatment)
Housing: Glass-filled PBT, UL94V-0
Reinforcing pin: Brass, copper-undercoated, tin-plated (reflow treatment)

RoHS compliance This product displays (LF)(SN) on a label.

Receptacle

Retention lock type Resin hook type

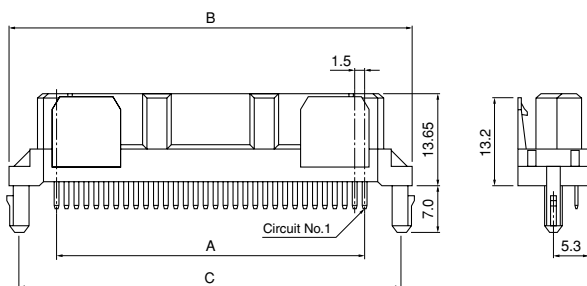

Metal hook type

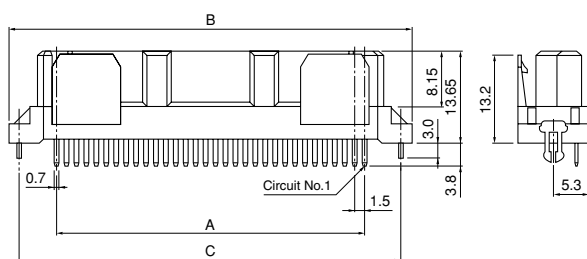

Resin hook type

Circuits	Model No.	Dimensions (mm)			Qty / box
		A	B	C	
15	JDV-R15LB-10-1	21.0	35.5	32.2	500
20	JDV-R20LB-10-1	28.5	43.0	39.7	400
25	JDV-R25LB-10-1	36.0	50.5	47.2	350
30	JDV-R30LB-10-1	43.5	58.0	54.7	300
35	JDV-R35LB-10-1	51.0	65.5	62.2	250
40	JDV-R40LB-10-1	58.5	73.0	69.7	200
50	JDV-R50LB-10-1	73.5	88.0	84.7	200

Material and Finish

Contact: Phosphor bronze, nickel-undercoated,
Mating part; gold-plated
Solder tail; tin-plated (reflow treatment)
Housing: Glass-filled PBT, UL94V-0

RoHS compliance This product displays (LF)(SN) on a label.

Metal hook type

Circuits	Model No.	Dimensions (mm)			Qty / box
		A	B	C	
20	JDV-R20LB-10A	28.5	43.0	39.7	400
25	JDV-R25LB-10A	36.0	50.5	47.2	350
30	JDV-R30LB-10A	43.5	58.0	54.7	300
35	JDV-R35LB-10A	51.0	65.5	62.2	250
40	JDV-R40LB-10A	58.5	73.0	69.7	200
50	JDV-R50LB-10A	73.5	88.0	84.7	200
65	JDV-R65LB-10A	96.0	110.5	107.2	150

Material and Finish

Contact: Phosphor bronze, nickel-undercoated,
Mating part; gold-plated
Solder tail; tin-plated (reflow treatment)
Housing: Glass-filled PBT, UL94V-0
Reinforcing pin: Brass, copper-undercoated, tin-plated (reflow treatment)

RoHS compliance This product displays (LF)(SN) on a label.