

Product description	M12-A connecting cord for food and beverage industry, Contacts: 3, not shielded, moulded on cable, IP69K, Ecolab, FDA compliant, M12x1, Standard cable, PP grey, 3 x 0.34 mm²
Area	M12-A series 763
Order number	77 3734 3729 40403-0500

Illustration

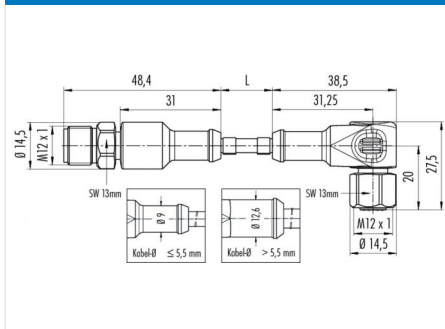

Scale drawing



Contact arrangement

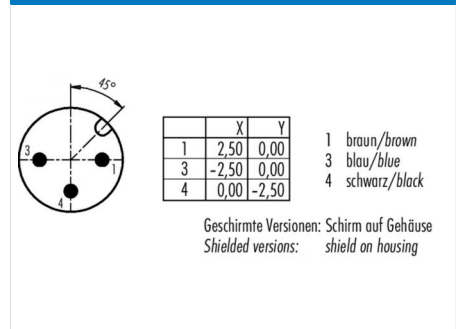

Technical data

General values

Connector design	connecting cord for food and beverage industry
Connector locking system	screw
Termination	moulded on cable
Wire gauge (mm)	0.34 mm ²
Wire gauge (AWG)	22
Upper limit temperature	105 °C
Lower limit temperature	- 40 °C
Customs tariff number	85444290

Cable data

Cable length	5 m
Sheath material	PP
Single-lead insulation	PVC
Single-lead structure	42 x 0,1 mm
Cable diameter	4.5 mm
Conductor resistance	57 Ω/Km
Temperature range, moving cable, °C from	- 5 °C
Temperature range, moving cable, °C to	105 °C
Temperature range, fixed cable, °C from	-40 °C
Temperature range, fixed cable, °C to	105 °C
Bending radius, fixed cable	≥ 5 x Ø
Bending radius, moving cable	≥ 10 x Ø
Approval 1	Ecolab
Approval 2	FDA compliant
UL style 1	AWM2517

Electrical values

Rated current (40 °C)	4 A
Rated voltage	250 V
Rated impulse voltage	2500 V
Pollution degree	3
Overvoltage category	II
Insulating material group	II
Insulation resistance	≥ 10 ¹⁰ Ω
EMC compliance	not shielded
Degree of protection	IP69K IP67
Degree of protection 2	IP67
Mechanical operation	> 100 Mating cycles

Material

Contact material	Pin: CuZn (brass) / Socket: CuSn (bronze)
Contact plating	Au (gold)
Contact body material	PP
Housing material	PP

Product description	M12-A connecting cord for food and beverage industry, Contacts: 3, not shielded, moulded on cable, IP69K, Ecolab, FDA compliant, M12x1, Standard cable, PP grey, 3 x 0.34 mm²
Area	M12-A series 763
Order number	77 3734 3729 40403-0500

Security notices

The connector must not be connected or separated under load. Non-observance and incorrect use can result in personal injury.

The connectors are designed for use in plant, control system and electrical equipment. The end user is responsible for checking whether the connectors are suitable for use in other applications.

Connectors used in electrical circuits containing hazardous life parts must only be assembled and used by or under the supervision of persons with the requisite electrotechnical training, taking the applicable regulations and standards into account.

Connectors with degree of protection IP 67 and IP 68 are not suitable for use under water. When used outdoors, the connectors must be separately protected against corrosion. For further information about IP degrees of protection refer to 'Technical support' in the Download Centre.

To lock the cable connector to the equipment connector, the threaded ring is tightened until it is 'finger-tight' (approx. 50 cNm).