

Part number

# CKH 03 CA



Cover,CKH series, with 2 pegs, size "21.21",  
for male inserts, with eyelet

#### Product description

<b>Product type</b>	Cover
<b>Series</b>	CKH
<b>Closing type</b>	with 2 pegs
<b>Size</b>	size "21.21"
<b>Specification</b>	for male inserts, with eyelet

#### Technical data

<b>IP degree of protection</b>	IP44 (IP66/IP67/IP69 with CKRH 65/CKRH 65 D kits)
--------------------------------	---

#### Further technical details

<b>Weight</b>	0,10 g
<b>Operating temperature range (min, max)</b>	-40°C...+70°C

#### Material properties

<b>Main material</b>	Polyamide
<b>Colour</b>	RAL 7012 grey

#### General ordering information

<b>EAN13 code</b>	8015747275491
-------------------	---------------

#### Packaging Information

<b>Packaging length</b>	220,00 mm
<b>Packaging height</b>	130,00 mm
<b>Packaging width</b>	240,00 mm
<b>Packaging volume</b>	6,86 dm <sup>3</sup>
<b>Packaging description</b>	Carton box
<b>Packaging quantity</b>	100 Pcs
<b>Packaging EAN code</b>	8015747275507
<b>Sub-packaging description</b>	Plastic bag
<b>Sub-packaging quantity</b>	10 Pcs
<b>Sub-packaging EAN barcode</b>	8015747275514

Part number

# CKH 03 CA



## Catalogue drawings

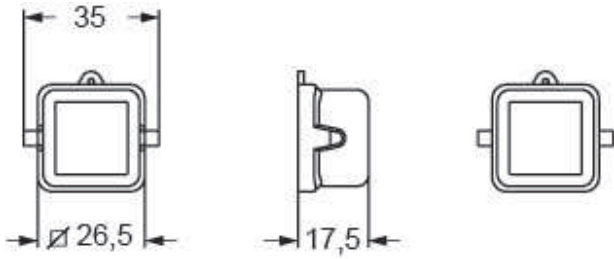

---

## Notes

Dimensions shown in mm are not binding and may be changed without notice.

---

Part number

# CKH 03 C



Cover,CKH series, with 2 pegs, size "21.21", for female inserts, with gasket and eyelet

#### Product description

<b>Product type</b>	Cover
<b>Series</b>	CKH
<b>Closing type</b>	with 2 pegs
<b>Size</b>	size "21.21"
<b>Specification</b>	for female inserts, with gasket and eyelet

#### Technical data

<b>IP degree of protection</b>	IP44 (IP66/IP67/IP69 with CKRH 65/CKRH 65 D kits)
--------------------------------	---

#### Further technical details

<b>Weight</b>	0,10 g
<b>Operating temperature range (min, max)</b>	-40°C...+70°C

#### Material properties

<b>Main material</b>	Polyamide
<b>Other materials</b>	Silicone rubber (gasket)
<b>Colour</b>	RAL 7012 grey

#### General ordering information

<b>EAN13 code</b>	8015747279604
-------------------	---------------

#### Packaging Information

<b>Packaging length</b>	220,00 mm
<b>Packaging height</b>	130,00 mm
<b>Packaging width</b>	240,00 mm
<b>Packaging volume</b>	6,86 dm <sup>3</sup>
<b>Packaging description</b>	Carton box
<b>Packaging quantity</b>	100 Pcs
<b>Packaging EAN code</b>	8015747279611
<b>Sub-packaging description</b>	Plastic bag
<b>Sub-packaging quantity</b>	10 Pcs
<b>Sub-packaging EAN barcode</b>	8015747279628

Part number

**CKH 03 C**



Catalogue drawings

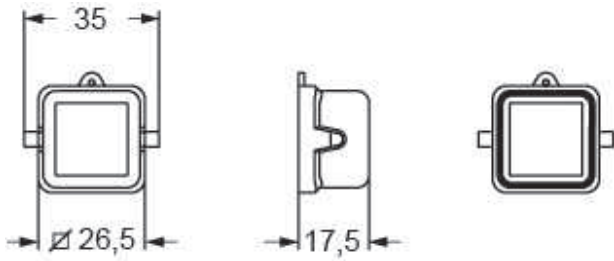

---

Notes

Dimensions shown in mm are not binding and may be changed without notice.

---

Part number

# CKH 03 CAS



Cover, CKH series, with 2 pegs, size "21.21", for male inserts, with loop

#### Product description

<b>Product type</b>	Cover
<b>Series</b>	CKH
<b>Closing type</b>	with 2 pegs
<b>Size</b>	size "21.21"
<b>Specification</b>	for male inserts, with loop

#### Technical data

<b>IP degree of protection</b>	IP44 (IP66/IP67/IP69 with CKRH 65/CKRH 65 D kits)
--------------------------------	---

#### Further technical details

<b>Weight</b>	0,10 g
<b>Operating temperature range (min, max)</b>	-40°C...+70°C

#### Material properties

<b>Main material</b>	Polyamide
<b>Colour</b>	RAL 7012 grey

#### General ordering information

<b>EAN13 code</b>	8015747275521
-------------------	---------------

#### Packaging Information

<b>Packaging length</b>	220,00 mm
<b>Packaging height</b>	130,00 mm
<b>Packaging width</b>	240,00 mm
<b>Packaging volume</b>	6,86 dm <sup>3</sup>
<b>Packaging description</b>	Carton box
<b>Packaging quantity</b>	100 Pcs
<b>Packaging EAN code</b>	8015747275538
<b>Sub-packaging description</b>	Plastic bag
<b>Sub-packaging quantity</b>	10 Pcs
<b>Sub-packaging EAN barcode</b>	8015747275545

Part number

# CKH 03 CAS



## Catalogue drawings

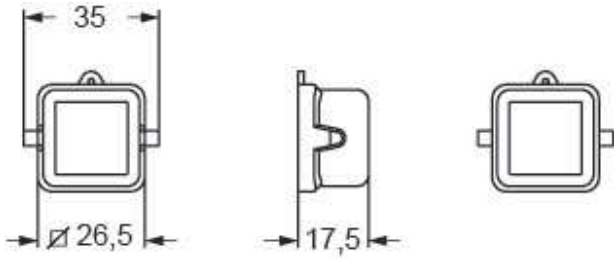

---

## Notes

Dimensions shown in mm are not binding and may be changed without notice.

---

Part number

# CKH 03 CS



Cover,CKH series, with 2 pegs, size "21.21",  
for female inserts, with gasket and loop

#### Product description

<b>Product type</b>	Cover
<b>Series</b>	CKH
<b>Closing type</b>	with 2 pegs
<b>Size</b>	size "21.21"
<b>Specification</b>	for female inserts, with gasket and loop

#### Technical data

<b>IP degree of protection</b>	IP44 (IP66/IP67/IP69 with CKRH 65/CKRH 65 D kits)
--------------------------------	---

#### Further technical details

<b>Weight</b>	0,10 g
<b>Operating temperature range (min, max)</b>	-40°C...+70°C

#### Material properties

<b>Main material</b>	Polyamide
<b>Other materials</b>	Silicone rubber (gasket)
<b>Colour</b>	RAL 7012 grey

#### General ordering information

<b>EAN13 code</b>	8015747279635
-------------------	---------------

#### Packaging Information

<b>Packaging length</b>	220,00 mm
<b>Packaging height</b>	130,00 mm
<b>Packaging width</b>	240,00 mm
<b>Packaging volume</b>	6,86 dm <sup>3</sup>
<b>Packaging description</b>	Carton box
<b>Packaging quantity</b>	100 Pcs
<b>Packaging EAN code</b>	8015747279642
<b>Sub-packaging description</b>	Plastic bag
<b>Sub-packaging quantity</b>	10 Pcs
<b>Sub-packaging EAN barcode</b>	8015747279659

Part number

# CKH 03 CS



## Catalogue drawings

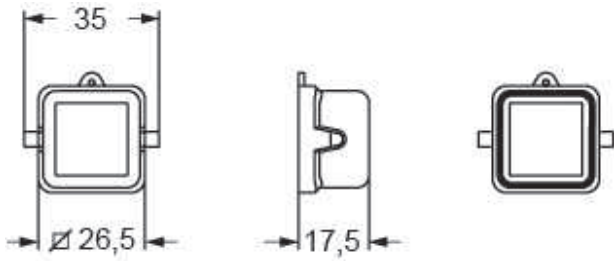

---

## Notes

Dimensions shown in mm are not binding and may be changed without notice.

---



Part number

# CKH 03 CX



Cover, CKH series, with 1 lever, size "21.21", for female inserts, with gasket and loop

#### Product description

<b>Product type</b>	Cover
<b>Series</b>	CKH
<b>Closing type</b>	with 1 lever
<b>Size</b>	size "21.21"
<b>Specification</b>	for female inserts, with gasket and loop

#### Technical data

<b>IP degree of protection</b>	IP44 (IP66/IP67/IP69 with CKRH 65/CKRH 65 D kits)
--------------------------------	---

#### Further technical details

<b>Weight</b>	0,10 g
<b>Operating temperature range (min, max)</b>	-40°C...+70°C

#### Material properties

<b>Main material</b>	Polyamide
<b>Other materials</b>	Polypropylene (lever), silicone rubber (gasket)
<b>Colour</b>	RAL 7012 grey, RAL 5015 blue

#### General ordering information

<b>EAN13 code</b>	8015747279666
-------------------	---------------

#### Packaging Information

<b>Packaging length</b>	245,00 mm
<b>Packaging height</b>	165,00 mm
<b>Packaging width</b>	215,00 mm
<b>Packaging volume</b>	8,69 dm <sup>3</sup>
<b>Packaging description</b>	Carton box
<b>Packaging quantity</b>	100 Pcs
<b>Packaging EAN code</b>	8015747279673
<b>Sub-packaging description</b>	Plastic bag
<b>Sub-packaging quantity</b>	10 Pcs
<b>Sub-packaging EAN barcode</b>	8015747279680

Part number

# CKH 03 CX



## Catalogue drawings

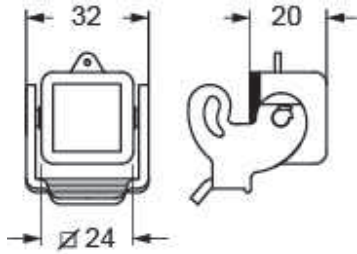

---

## Notes

Dimensions shown in mm are not binding and may be changed without notice.

---

Part number

# CKH 03 CXA



Cover, CKH series, with 1 lever, size "21.21", for male inserts, with loop

#### Product description

<b>Product type</b>	Cover
<b>Series</b>	CKH
<b>Closing type</b>	with 1 lever
<b>Size</b>	size "21.21"
<b>Specification</b>	for male inserts, with loop

#### Technical data

<b>IP degree of protection</b>	IP44 (IP66/IP67/IP69 with CKRH 65/CKRH 65 D kits)
--------------------------------	---

#### Further technical details

<b>Weight</b>	0,10 g
<b>Operating temperature range (min, max)</b>	-40°C...+70°C

#### Material properties

<b>Main material</b>	Polyamide
<b>Other materials</b>	Polypropylene (lever)
<b>Colour</b>	RAL 7012 grey, RAL 5015 blue

#### General ordering information

<b>EAN13 code</b>	8015747279697
-------------------	---------------

#### Packaging Information

<b>Packaging length</b>	245,00 mm
<b>Packaging height</b>	165,00 mm
<b>Packaging width</b>	215,00 mm
<b>Packaging volume</b>	8,69 dm <sup>3</sup>
<b>Packaging description</b>	Carton box
<b>Packaging quantity</b>	100 Pcs
<b>Packaging EAN code</b>	8015747279703
<b>Sub-packaging description</b>	Plastic bag
<b>Sub-packaging quantity</b>	10 Pcs
<b>Sub-packaging EAN barcode</b>	8015747279710

Part number

# CKH 03 CXA



Catalogue drawings

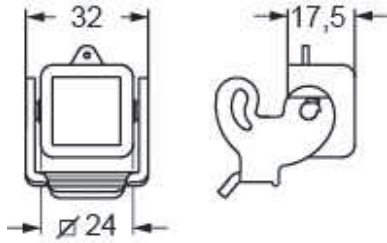

---

## Notes

Dimensions shown in mm are not binding and may be changed without notice.

---

Part number

# CKH 03 I



Bulkhead mounting housing, CKH series, with 1 lever, size "21.21"

#### Product description

<b>Product type</b>	Bulkhead mounting housing
<b>Series</b>	CKH
<b>Closing type</b>	with 1 lever
<b>Size</b>	size "21.21"

#### Technical data

<b>IP degree of protection</b>	IP44 (IP66/IP67/IP69 with CKRH 65/CKRH 65 D kits)
--------------------------------	---

#### Further technical details

<b>Weight</b>	0,10 g
<b>Operating temperature range (min, max)</b>	-40°C...+70°C

#### Material properties

<b>Main material</b>	Polyamide
<b>Other materials</b>	Polypropylene (lever), silicone rubber (gasket)
<b>Colour</b>	RAL 7012 grey, RAL 5015 blue

#### General ordering information

<b>EAN13 code</b>	8015747272001
-------------------	---------------

#### Packaging Information

<b>Packaging length</b>	200,00 mm
<b>Packaging height</b>	120,00 mm
<b>Packaging width</b>	360,00 mm
<b>Packaging volume</b>	8,64 dm <sup>3</sup>
<b>Packaging description</b>	Carton box
<b>Packaging quantity</b>	100 Pcs
<b>Packaging EAN code</b>	8015747272018
<b>Sub-packaging description</b>	Carton box
<b>Sub-packaging quantity</b>	10 Pcs
<b>Sub-packaging EAN barcode</b>	8015747272025

Part number

# CKH 03 I



Catalogue drawings

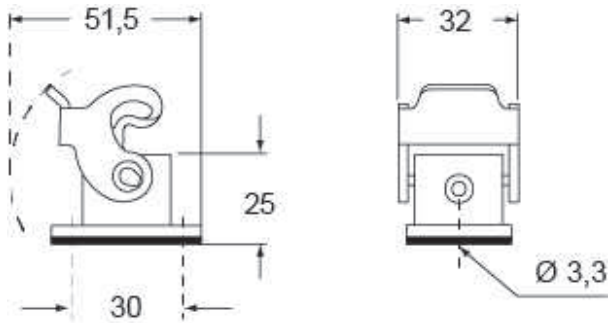

Catalogue drawings

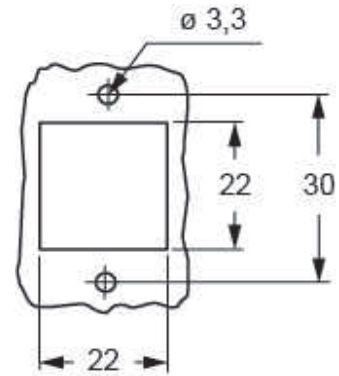

## Notes

Dimensions shown in mm are not binding and may be changed without notice.

Part number

# CKH 03 IA



Angled Bulkhead mounting housing, CKH series, with 1 lever without cable entry, size "21.21"

#### Product description

<b>Product type</b>	Angled bulkhead mounting housing
<b>Series</b>	CKH
<b>Closing type</b>	with 1 lever
<b>Size</b>	size "21.21"
<b>Cable entry</b>	without cable entry

#### Technical data

<b>IP degree of protection</b>	IP44 (IP66/IP67/IP69 with CKRH 65/CKRH 65 D kits)
--------------------------------	---

#### Further technical details

<b>Weight</b>	0,10 g
<b>Operating temperature range (min, max)</b>	-40°C...+70°C

#### Material properties

<b>Main material</b>	Polyamide
<b>Other materials</b>	Polypropylene (lever), silicone rubber (gasket)
<b>Colour</b>	RAL 7012 grey, RAL 5015 blue

#### General ordering information

<b>EAN13 code</b>	8015747275552
-------------------	---------------

#### Packaging Information

<b>Packaging length</b>	360,00 mm
<b>Packaging height</b>	165,00 mm
<b>Packaging width</b>	315,00 mm
<b>Packaging volume</b>	18,71 dm <sup>3</sup>
<b>Packaging description</b>	Carton box
<b>Packaging quantity</b>	100 Pcs
<b>Packaging EAN code</b>	8015747275569
<b>Sub-packaging description</b>	Carton box
<b>Sub-packaging quantity</b>	10 Pcs
<b>Sub-packaging EAN barcode</b>	8015747275576

Part number

# CKH 03 IA



Catalogue drawings

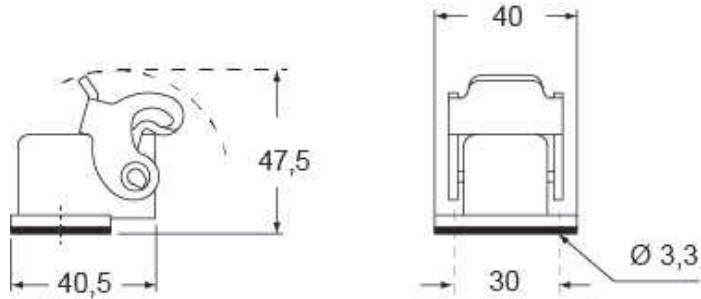

Catalogue drawings

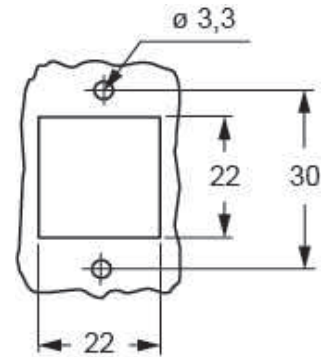

## Notes

Dimensions shown in mm are not binding and may be changed without notice.

---